

Data Sheet

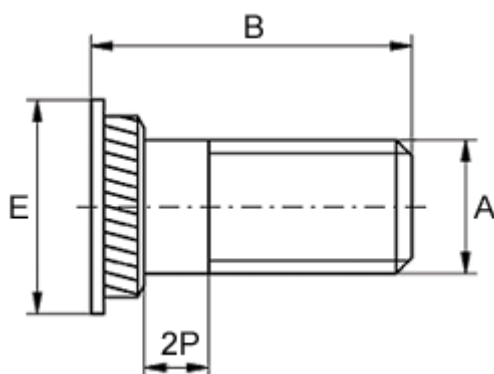

Article number: 12517700050500
Description: KLEE-coil 517 700 050.500
M5 Stainless 14305

Measures



For plate thickness, min	= 1.5
Head diameter E	= 8
Hole diameter +0.1	= 6.4
Length B	= 17
Male thread A	= M5x0,8
Min distance to edge	= 3.3